

Development of a Dual-Sided Readout DOI-PET Module Using Large-Area Monolithic MPPC-Arrays

Aya Kishimoto, Jun Kataoka, Takuya Kato, Takamasa Miura, Takeshi Nakamori, Kei Kamada, Shigeyuki Nakamura, Kenichi Sato, Yoshitaka Ishikawa, Kazuhisa Yamamura, Nobuyuki Kawabata, and Seiichi Yamamoto

Abstract—We are proposing a novel design for a module with depth of interaction (DOI) capability for gamma rays by measuring the pulse-height ratio of double-sided Multi-Pixel Photon Counters (MPPCs) coupled at both ends of a scintillation crystal block. Thanks to newly developed monolithic MPPC arrays consisting of 4×4 channels with a three-side buttable package, the module is very thin and compact, thereby enabling less dead space between each module when arranged into a fully designed gantry. To demonstrate our concept of a DOI measuring technique, we first made a 1-D crystal array consisting of five Ce-doped $\text{Gd}_3\text{Al}_2\text{Ga}_3\text{O}_{12}$ (Ce:GAGG) cubic crystals measuring $3 \times 3 \times 3 \text{ mm}^3$ in size, separated by a layer of air approximately $10 \mu\text{m}$ -thick. When the light signals output from both ends are read with the $3 \times 3 \text{ mm}^2$ MPPCs, the position of each crystal is clearly distinguished. The same measurements were also made using Ce-doped $(\text{Lu}, \text{Y})_2(\text{SiO}_4)\text{O}$ (Ce:LYSO), achieving a similarly good separation. We then fabricated thin Ce:GAGG 2-D crystal arrays consisting of two types: [A] 4×4 matrix of $3 \times 3 \times 3 \text{ mm}^3$ pixels, and [B] 10×10 matrix of $0.8 \times 0.8 \times 5 \text{ mm}^3$ pixels, with each pixel divided by a BaSO_4 reflector 0.2 mm -thick. Then four arrays are laid on top of each other facing the DOI direction through a layer of air $10 \mu\text{m}$ -thick. We demonstrated that the 3-D position of each Ce:GAGG pixel is clearly distinguished in both the 2-D and DOI directions for type A and B when illuminated by 662 keV gamma rays. Average energy resolutions of $9.8 \pm 0.8\%$ and $11.8 \pm 1.3\%$ were obtained for types A and B, respectively. These results suggest that our proposed method is simple and offers promise in achieving both excellent spatial and energy resolutions for future medical imaging, particularly in positron emission tomography (PET).

Index Terms—Depth of Interaction (DOI), Multi-Pixel Photon Counter (MPPC), Positron Emission Tomography (PET).

I. INTRODUCTION

POSITRON EMISSION TOMOGRAPHY (PET) imaging has been developed to detect cancers and diagnose Alzheimer's in its early stages [1]. In order to achieve a high

spatial resolution over the entire field of view (FOV), the depth of interaction (DOI) technique is often suggested for preventing parallax error which leads to degraded spatial reconstruction resolution, especially along the peripheral FOV. One of the simplest ways of measuring DOI is to read out the scintillation light from both ends, although such conventional photodetectors as a photomultiplier tube (PMT) are bulky and difficult to implement at both ends of crystal arrays [2].

A detector that is optically coupled to a one-sided, position-sensitive photomultiplier tube (PS-PMT) and controls the path of scintillation photons by inserting reflectors between the crystal elements at different layer-by-layer positions has also been developed [3], [4]. Another technique is the phoswich detector that contrives the pulse shape discrimination of several scintillation crystal arrays consisting of different decay time constants [5].

In recent years, a number of DOI-PET detectors using newly developed silicon photomultipliers (commonly known as Si-PM) have been proposed. Now the most common technique to measure DOI is the “dual-sided” readout of scintillation crystal arrays, given the great advantage afforded by a solid-state photosensor having a thin and compact geometry [6]–[8]. Moreover, a new detector featuring a novel design (called the X'tal cube) was recently developed [9]. The X'tal cube can read out scintillation light signals by using a number of Multi-Pixel Photon Counters (MPPCs) coupled on all six surfaces of a segmented scintillation crystal array, and has achieved 1 mm spatial resolution in all three-dimensional (3-D) directions [10]. When, considering the large number of modules expected to be implemented in a single PET gantry, however, precise position encoding performance, simple fabrication, and easy signal data processing are all desired.

Under these circumstances, we have proposed a novel design for a module with DOI capability for gamma rays by using large-area monolithic MPPC arrays that were recently developed [11], [12], and coupled at both ends of a scintillator crystal block. Although our method utilizes the pulse height ratio from the top and bottom of the MPPCs as has been proposed in previous literature, it differs in many aspects to achieve excellent performance in terms of spatial and spectral energy resolutions, along with a simple configuration. We first describe our concept of a novel DOI detector using a 1-D crystal array. We then demonstrate how our method is easily applicable to multiple 2-D scintillator arrays regarded as an assembly of 1-D crystal arrays separated by BaSO_4 reflectors, in order to achieve sub-millimeter 3-D resolution.

Manuscript received March 22, 2012; revised July 04, 2012, August 30, 2012, and October 26, 2012; accepted December 05, 2012. Date of publication January 30, 2013; date of current version February 06, 2013.

A. Kishimoto, J. Kataoka, T. Kato, T. Miura, and T. Nakamori are with Research Institute for Science and Engineering, Waseda University, 3-4-1, Ohkubo, Shinjuku, Tokyo, Japan (e-mail: daphne3h-aya@ruri.waseda.jp).

K. Kamada is with Materials Research Laboratory, Furukawa Co., Ltd., 1-25-13, Kannondai, Tsukuba, Ibaraki 305-0856, Japan.

S. Nakamura, K. Sato, Y. Ishikawa, K. Yamamura, and N. Kawabata are with Solid State Division, Hamamatsu Photonics K. K., 1126-1, Ichino-cho, Hamamatsu, Shizuoka, Japan.

S. Yamamoto is with the Kobe City College of Technology, 621-2194, Nishi-ku, Kobe, Japan.

Color versions of one or more of the figures in this paper are available online at <http://ieeexplore.ieee.org>.

Digital Object Identifier 10.1109/TNS.2012.2233215

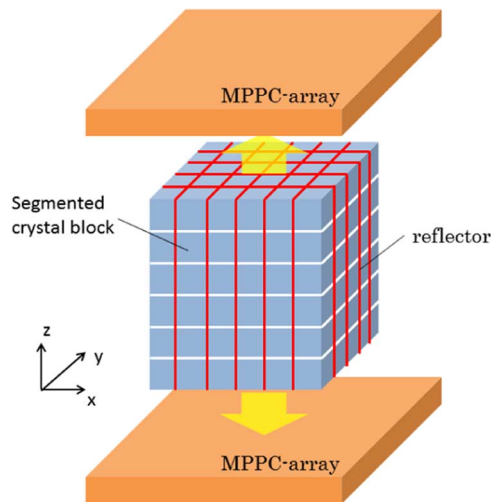

Fig. 1. Schematic illustration of our DOI system. The walls of BaSO_4 reflectors divide side-by-side crystals in the 2-D direction, while a thin layer of air divides crystals in the DOI direction. Scintillation light is read by dual-sided MPPCs arrays at the top and bottom end of the crystal block.

TABLE I
BASIC CHARACTERISTICS OF THE GAGG SCINTILLATOR

Density (g/cm^3)	6.63
Effective atomic number	51
Light yield (photon/MeV)	42,000
Decay time (nsec)	52.8(73%) and 282(27%)
Peak wavelength (nm)	520

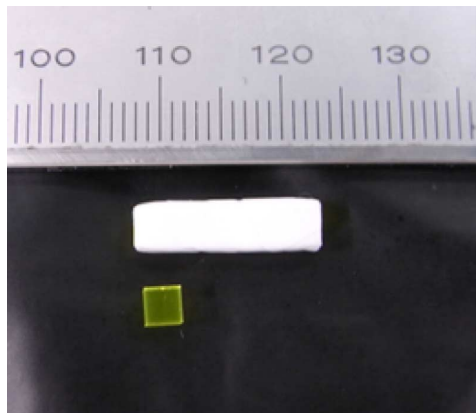

Fig. 2. Photo of the 1-D GAGG crystal array to demonstrate our concept of a DOI measuring method. The unit consists of five GAGG elements, each having dimensions of $3 \times 3 \times 3 \text{ mm}^3$.

II. EXPERIMENTAL DETAILS

A. Concept of a Novel DOI Detector

Fig. 1 shows a schematic illustration of our DOI module. Note that the walls of reflectors (BaSO_4 in our case) divide side-by-side crystals in the 2-D direction, while a thin layer of air divides crystals in the DOI direction. When a gamma ray is absorbed in a certain scintillator pixel, photons spread toward the DOI direction, which is finally read out by MPPC arrays at the top or bottom end of the crystal block. By taking the pulse-height ratio between two MPPC arrays, we can easily identify the DOI

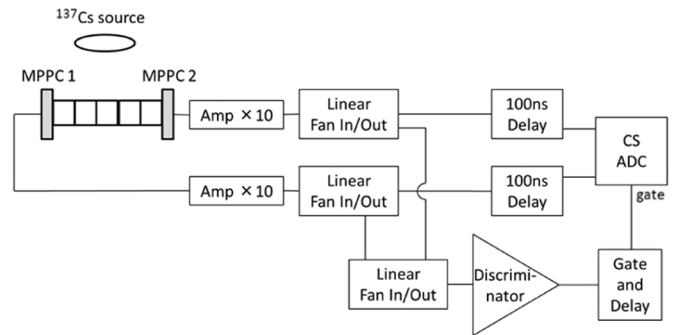

Fig. 3. Diagram of the readout system used for 1-D GAGG array measurement.

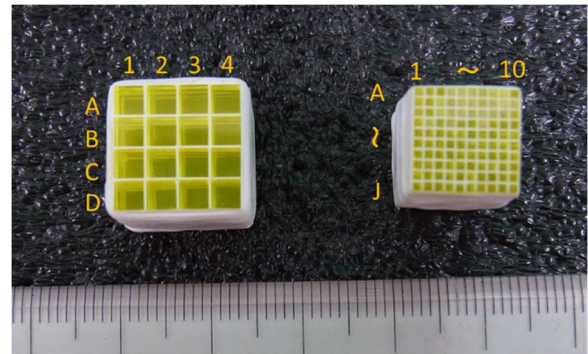

Fig. 4. Photo of 3-D GAGG crystal arrays. The array on the left consists of four layers of type A GAGG arrays (3 mm-thick); the array on the right consists of four layers of type B GAGG arrays (5 mm-thick).

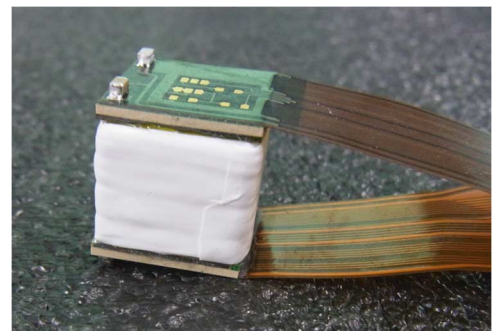

Fig. 5. Photo of experimental setup for 3-D crystal arrays. Two MPPC arrays are optically coupled to the top and bottom sides of the crystal arrays. The output charge signals from both MPPC arrays are read out via FPC cable.

position. Meanwhile, 2-D positions can be easily calculated by using the centroid method as detailed below. Also refer to [12], [13].

The conventional dual-sided DOI detector often uses a crystal block consisting of uniform strip scintillators with no division toward the DOI direction. Making a significant gradient of light outputs depending on the DOI position requires a rough or tapered crystal surface, inevitably resulting in a loss of light signals and/or more dead space. In case of X'tal cube detector, however, internal reflectors are removed to spread the scintillation photons in 3-D space, but all six surfaces must be fully covered by the MPPC to detect as many photons as possible.

Instead, we constructed a crystal block consisting of discrete scintillators with a polished surface. Some scintillation light

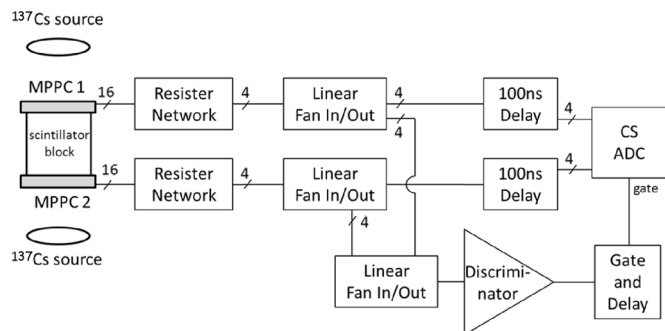

Fig. 6. Diagram of the readout system used for 3-D GAGG scintillator block measurement.

is reflected at its boundary due to the difference in refractive index. With this technique, we can make a substantial gradient of output signals at both ends (depending on the DOI position), by restricting the spread of scintillation light only toward the DOI direction.

B. GAGG Scintillator

As described in this paper, we used Ce-doped $Gd_3Al_2Ga_3O_{12}$ (Ce:GAGG) as scintillation material configured for our DOI detector. Ce:GAGG is a brand-new scintillator with high light yield [14]. It has density of 6.63 g/cm^3 and an effective atomic number of 51. They are slightly smaller than conventional PET scintillators such as LYSO and BGO crystals, but its high light yield of over 40,000 photons/MeV helps improve the signal-to-noise (S/N) ratio and energy resolution. Table I lists the other basic characteristics of Ce:GAGG.

C. Monolithic MPPC-Array

The MPPC array described in this paper is the monolithic 4×4 array developed by Hamamatsu Photonics K.K (S11830-3344MB(X)). Each channel has a photosensitive area of $3 \times 3 \text{ mm}^2$ and 60×60 Geiger mode APDs arranged with a pitch of $50 \mu\text{m}$. The gap between each channel is only 0.2 mm thanks to the monolithic structure. The MPPC array is placed on a surface-mounted package measuring $14.3 \times 13.6 \text{ mm}^2$ and fabricated into a three-side buttable structure. Signals from individual channels can be read via a flexible printed circuit (FPC) cable that easily connects the MPPC array to subsequent electronic circuits. The average gain of the MPPC arrays described in this paper was 1.0×10^6 at a typical operating voltage of 72.1 V , with gain fluctuation of only $\pm 7.3\text{--}7.8\%$ over 4×4 MPPC pixels as measured at 20°C . The dark count rate due to the 1 p.e. level was about 300 to 400 kcps per pixel. Refer to [12] for more details on MPPC array performance.

D. Experimental Setup for Verification Test

To demonstrate our concept of a DOI measuring method, we first made a 1-D crystal array consisting of five Ce:GAGG cubic crystals measuring $3 \times 3 \times 3 \text{ mm}^3$ in size. We did not use any optical compounds between each cubic crystal, which were separated by a layer of air approximately $10 \mu\text{m}$ -thick. The entire array is covered with Teflon reflectors except at both ends as shown in Fig. 2. In this experiment, $3 \times 3 \text{ mm}^2$ pixel-

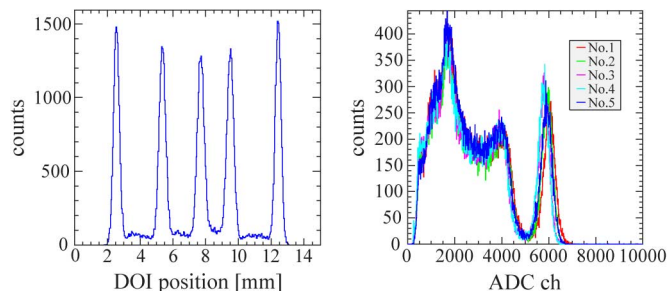

Fig. 7. *Left*: Position histogram for the 1-D GAGG array under uniform irradiation of 662 keV gamma rays. Only photo-absorbed events at $662 \pm 66.5 \text{ keV}$ were selected for use. *Right*: Energy spectra corresponding to five crystals irradiated by 662 keV gamma ray. The average energy resolution is $9.2 \pm 0.4\%$ for 662 keV gamma rays, as measured at 20°C .

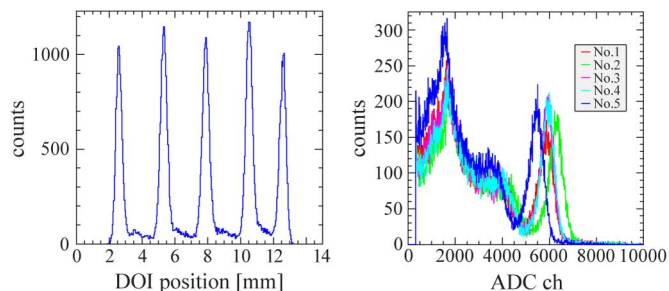

Fig. 8. *Left*: Position histogram for the 1-D LYSO array under uniform irradiation of 662 keV gamma rays. Only photo-absorbed events at $662 \pm 66.5 \text{ keV}$ were selected for use. *Right*: Energy spectra corresponding to five crystals irradiated by 662 keV gamma ray. The average energy resolution is $12.0 \pm 0.7\%$ for 662 keV gamma rays, as measured at 20°C .

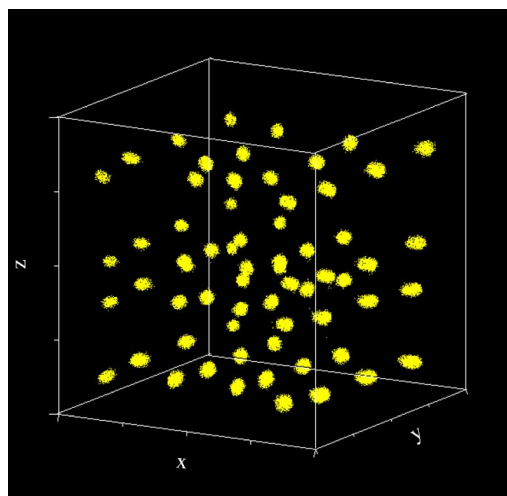

Fig. 9. 3-D position histogram for type A crystal block, as measured for 662 keV gamma rays.

type MPPCs (S1032-33-025C) were used instead of the MPPC-array described above, in order to accommodate the crystal size. MPPCs were coupled to each end of the scintillator array with optical grease (OKEN6262A).

Fig. 3 shows a schematic diagram of the readout system for this simple experiment. The output charge signals from both MPPCs are fed into a fast current amplifier (Philips MODEL6954), and then divided into two lines. One line was directly fed to the charge-sensitive ADC (HOSHIN V005;

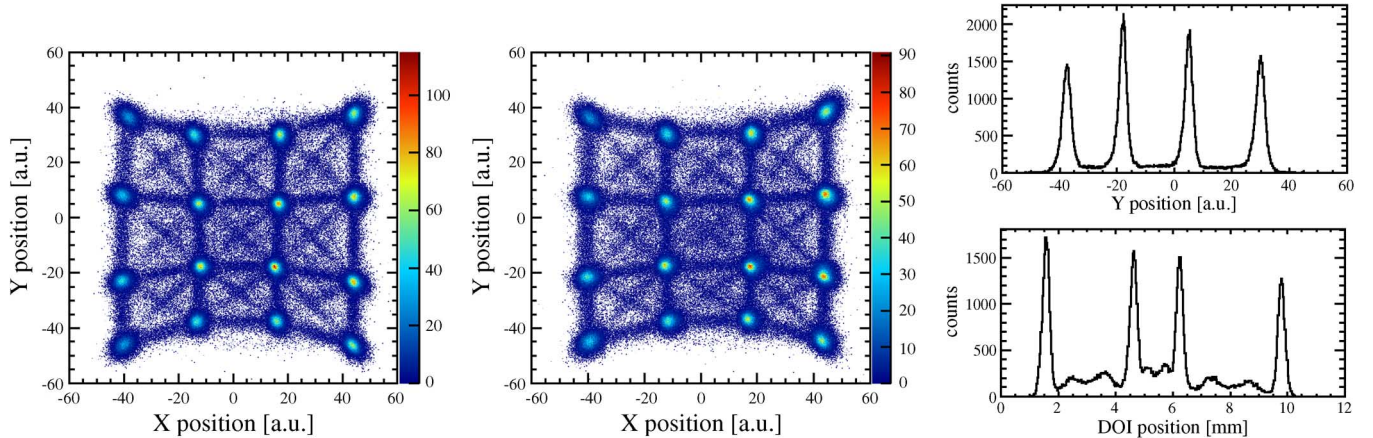

Fig. 10. *Left*: 2-D position map of 1st layer of the type A crystal array. *Center*: 2-D position map of 2nd layer of the type A crystal array. *Right*: Count profiles in the Y direction from the column second from the right of the 1st layer (*top*), and in the DOI direction from line C-3 (defined in Fig. 4) (*bottom*).

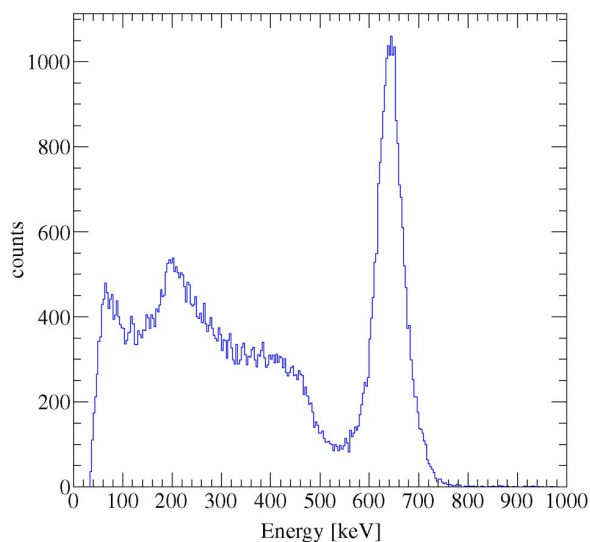

Fig. 11. Energy spectrum of the representative element of the type A array (c-3 of layer 2). The averaged energy resolution for the 662 keV photoelectric peak was $9.8 \pm 0.8\%$.

hereafter CSADC), with the other being summed to generate a trigger for the data acquisition system. The gate width of the CSADC was set to 650 ns. The sum of the two output signals corresponded to the total energy deposition of gamma rays, while the DOI position (z) is calculated by the following equation:

$$z = \frac{LS_1}{(S_1 + S_2)} \quad (1)$$

where, L denotes the entire length of the scintillator array ($3 \text{ mm} \times 5 = 15 \text{ mm}$ in this case). Each Ce:GAGG pixel is almost uniformly irradiated by 662 keV gamma rays from a ^{137}Cs source. The measurement was conducted at 20°C .

To confirm that the method presented above is also applicable to other scintillators, the same measurements were also made using Ce-doped $(\text{Lu}, \text{Y})_2(\text{SiO}_4)\text{O}$ (Ce:LYSO) crystals.

E. Experimental Setup for 3-D Measurement

For the 3-D measurements, we fabricated two different types of Ce:GAGG 2-D crystal arrays consisting of two types: [A] 4

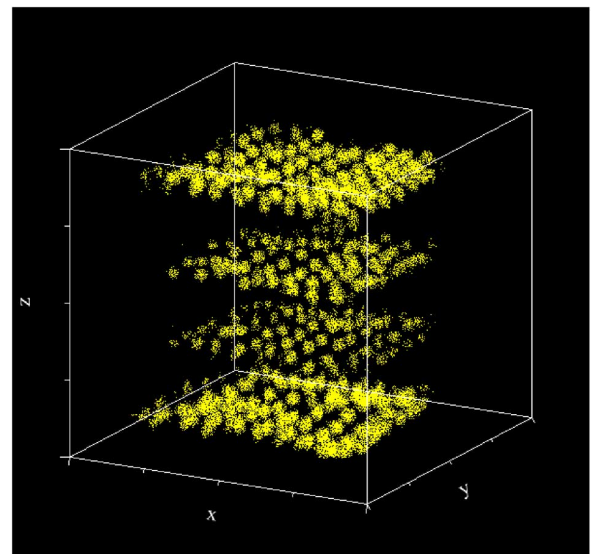

Fig. 12. 3-D position histogram for type B crystal block, as measured for 662 keV gamma rays.

$\times 4$ matrix of $3 \times 3 \times 3 \text{ mm}^3$ pixels and [B] 10×10 matrix of $0.8 \times 0.8 \times 5 \text{ mm}^3$ pixels, where each pixel is divided by a BaSO_4 reflector 0.2 mm-thick. Then four arrays are laid out on top of each other toward the DOI direction through a layer of air approximately $10 \mu\text{m}$ -thick (Fig. 4). Then the outermost shield of each “crystal blocks” consisting of four layers (type [A] or [B] arrays) was wrapped and tightened with Teflon tape. Fig. 5 shows a photo of the DOI module used for this experiment.

For measuring the type B crystal block, we used light guides 1 mm-thick between the MPPC arrays and crystal block to further spread scintillation light over the MPPC arrays. Fig. 6 illustrates the setup for measuring the 3-D crystal block. To reduce the number of output signal channels, we applied a charge division readout technique based on a resistor network developed by [12], [13]. The resistor network shown in Fig. 6 was used only to reduce the number of read-out channels, and not for any signal amplification. The sum of the eight output signals corresponded to the total energy deposition of gamma rays, with the x , y and z ($=$ DOI) interaction positions being calculated by

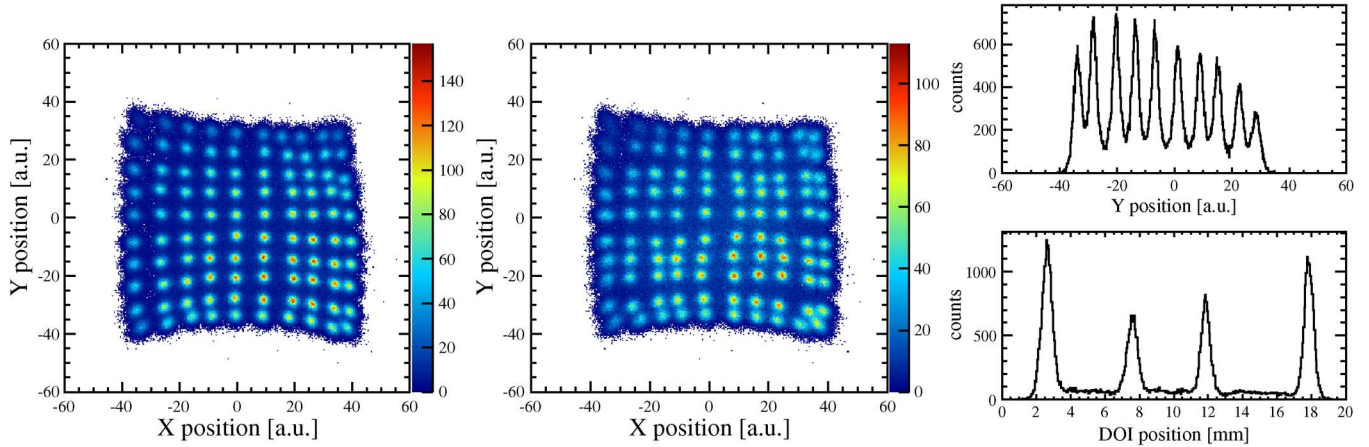

Fig. 13. *Left*: 2-D position map of 1st layer of the type B crystal array. *Center*: 2-D position map of 2nd layer of the type B crystal array. *Right*: Count profiles in the Y direction from the 5th column of the 1st layer (*top*), and in the DOI direction from line F-6 (defined in Fig. 4) (*bottom*).

using the centroid method, as expressed by the following equation;

$$X = \frac{W((X_{1+} + X_{2+}) - (X_{1-} + X_{2-}))}{(S_1 + S_2)} \quad (2)$$

$$Y = \frac{W((Y_{1+} + Y_{2+}) - (Y_{1-} + Y_{2-}))}{(S_1 + S_2)} \quad (3)$$

$$Z = \frac{LS_1}{(S_1 + S_2)} \quad (4)$$

where, X_{i+} , X_{i-} , Y_{i+} , and Y_{i-} ($i = 1$ or 2) denote the charge recorded from each side of the resistor network, S_1 and S_2 denote the total charge recorded for the top and bottom MPPC arrays, that is, $S_i = X_{i+} + X_{i-} + Y_{i+} + Y_{i-}$, W denotes a coefficient corresponding to the 2-D direction length of the scintillator array, and L denotes the DOI direction length of the scintillator array. Again, we irradiated 662 keV gamma rays uniformly, and measured all data at 20°C.

III. RESULTS AND DISCUSSION

A. Performance Test Using the 1-D GAGG Array

Fig. 7 (*left*) shows the resultant position histogram for the 1-D Ce:GAGG array, where only photo-absorbed events are used for calculation (662 ± 66.5 keV). The horizontal axis corresponds to the DOI position as described in (1). Note that all peaks corresponding to each of the five cubic crystals can be clearly distinguished. This experiment provides an interesting possibility for a relatively simple way of achieving moderate DOI resolution, which is easily extendable to fine-pixel 2-D arrays.

Fig. 7 (*right*) shows the energy spectra obtained for each Ce:GAGG crystal. The averaged energy resolution amounts to $9.2 \pm 0.4\%$ (FWHM) for 662 keV gamma rays, as measured at 20°C.

Similarly, Fig. 8 shows the resultant position histogram and energy spectra of the Ce:LYSO array. All five Ce:LYSO crystals, as is the case with Ce:GAGG, can be clearly distinguished. The averaged energy resolution for 662 keV gamma rays was $12.0 \pm 0.7\%$ (FWHM). The photo-electric fractions of Ce:GAGG and of Ce:LYSO obtained from energy spectra

were 14% and 21%. This rate depends on the effective atomic number of the scintillation material. Since the effective atomic number of Ce:GAGG ($Z_{eff} = 51$) is slightly lower than those of BGO ($Z_{eff} = 75$) and GSO ($Z_{eff} = 59$), Ce:GAGG has a disadvantage in terms of coincidence-detection sensitivity. Nevertheless, the high light output of Ce:GAGG contributes to high spatial and energy resolution. In addition, the position determination method proposed in this paper can be applied to other scintillation materials; therefore, in cases where more weight is attached to sensitivity, we can use other scintillators.

B. Performance Test Using 2-D GAGG Arrays

Figs. 9 to 11 show the compiled results of a performance test conducted using the type A GAGG. Particularly noteworthy is Fig. 9, which presents the 3-D position histogram of each crystal, as measured for 662 keV full depleting gamma rays at 20°C. Fig. 10 (*left* and *center*) shows an example 2-D position map of each layer, together with the count profiles projected in the Y direction (*right top*) and DOI direction (*right bottom*). From these results, we can see that all crystals are clearly resolved in both the 2-D and DOI directions. Fig. 11 shows the energy spectrum of the representative element of type A. The averaged energy resolution for the 662 keV photoelectric peak was $9.8 \pm 0.8\%$.

Similarly, Figs. 12 to 14 show the compiled results of a performance test conducted using the type B GAGG block, corresponding to a 3-D position histogram, representative 2-D position map, and count profiles projected in the Y or DOI direction. In particular, the 2-D position map of type B confirms that our DOI system can achieve excellent submillimeter spatial resolution in the X-Y direction. The average energy resolution for 662 keV was $11.8 \pm 1.3\%$.

The energy resolution of type B is slightly worse as compared to type A. There are several conceivable reasons for this result. First, even a subtle positional mismatch between each layer could prove more problematic for fine-pixel arrays like type B, especially when the blocks are manually fabricated without each layer being carefully aligned. Secondly, the transmission of scintillation light may affect the results, though such effect is considered relatively minor.

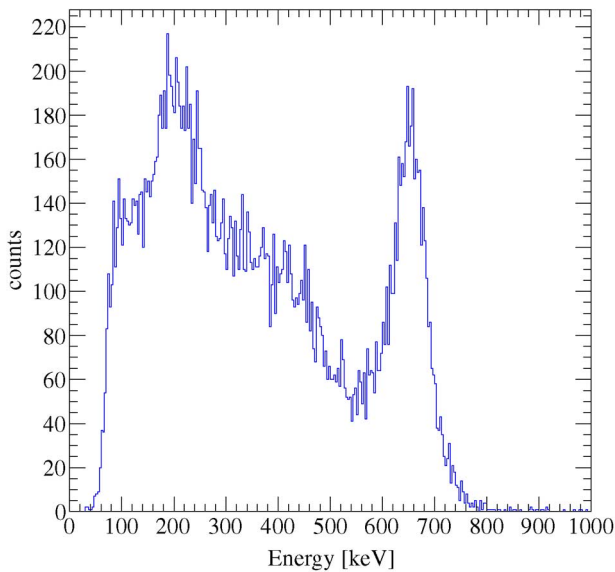

Fig. 14. Energy spectrum of the representative element of the type B array (crystal element f-6 of layer 2). The averaged energy resolution for the 662 keV photoelectric peak was $11.8 \pm 1.3\%$.

In the next step, we plan to fabricate 1 mm- or 2 mm-thick GAGG arrays of more than 10 layers, which also provide sub-millimeter resolution in the 2-D direction, in order to further demonstrate the capability of the DOI methods presented in this paper.

IV. CONCLUSION

In this work, we proposed a novel technique of measuring the 3-D positions of gamma-ray absorption based on newly developed large-area monolithic arrays and a new Ce:GAGG scintillator block. Given a relatively simple way of using the centroid method, we successfully demonstrated that the position of each crystal can be clearly resolved. Moreover, excellent energy resolutions of $9.8 \pm 0.8\%$ and $11.8 \pm 1.3\%$ were obtained for types A and B, respectively, as measured for 662 keV gamma rays. The application of the method of measuring the 3-D positions of gamma-ray absorption could not be restricted to PET scanners. For example, this is useful for improving the resolution of a gamma-camera which takes an image at very close range and has the significant effect of parallax error. Although certain technical issues remain to be addressed, especially the align-

ment of each 2-D array, our simple method provides interesting possibilities for future imaging techniques.

REFERENCES

- [1] W. W. Moses, "Trends in PET imaging," *Nucl. Instr. Meth.*, vol. A471, pp. 209–214, 2001.
- [2] A. Braem, M. Chamizo, E. Chesi, N. Colonna, F. Cusanno, R. De Leo, F. Garibaldi, C. Joram, S. Mathot, E. Nappi, F. Schoenahi, J. Seguinot, P. Weilhammer, and H. Zaidi, "Novel design of a parallax free Compton enhanced PET scanner," *Nucl. Instr. Meth.*, vol. A525, pp. 268–274, 2004.
- [3] H. Murayama, H. Ishibashi, H. Uchida, T. Omura, and T. Yamashita, "Depth encoding multicrystal detector for PET," *IEEE Trans. Nucl. Sci.*, vol. 45, pp. 1152–1157, 1998.
- [4] T. Tsuda, H. Murayama, K. Kitamura, T. Yamaya, E. Yoshida, T. Omura, H. Kawai, N. Inadama, and N. Orita, "A four layer depth of interaction detector block for small animal PET," *IEEE Trans. Nucl. Sci.*, vol. 51, pp. 2537–2542, 2004.
- [5] J. Seidel, J. J. Vaquero, S. Siegel, W. R. Gandler, and M. V. Green, "Depth identification accuracy of a three layer phoswich PET detector module," *IEEE Trans. Nucl. Sci.*, vol. 46, no. 3, pp. 485–490, 1999.
- [6] E. P. Delifino, S. Majewski, R. R. Raylman, and A. Stolin, "Towards 1 mm PET resolution using DOI modules based on dual-sided SiPM readout," in *IEEE Nucl. Sci. Symp. Conf. Rec.*, 2010, pp. 3442–3449.
- [7] P. Dokhale, C. Staples, J. Christian, Y. Yang, S. Cherry, W. Moses, and K. Shah, "Performance measurements of a SSPM-LYSO-SSPM detector module for small animal positron emission tomography," in *IEEE Nucl. Sci. Symp. Conf. Rec.*, 2009, pp. 2809–2812.
- [8] F. Taghibakhsh, S. Cuddy, T. Rvachov, D. Green, A. Reznik, and J. A. Rowlands, "Detectors with dual-ended readout by silicon photomultipliers for high resolution positron emission mammography applications," in *IEEE Nucl. Sci. Symp. Conf. Rec.*, 2009, pp. 2821–2826.
- [9] Y. Yazaki, H. Murayama, N. Inadama, H. Osada, F. Nishikido, K. Shibuya, T. Yamaya, E. Yoshida, M. Suga, T. Moriya, M. Watanabe, T. Yamashita, and H. Kawai, "The 'X'tal cube' PET detector: 3D scintillation photon detection of a 3D crystal array using MPPCs," in *IEEE Nucl. Sci. Symp. Conf. Rec.*, 2009, M13-267.
- [10] T. Mitsuhashi, N. Inadama, F. Nishikido, E. Yoshida, H. Murayama, H. Kawai, M. Suga, H. Haneishi, K. Shibuya, M. Watanabe, and T. Yamaya, "1 mm isotropic detector resolution achieved by X'tal cube detector," in *IEEE Nucl. Sci. Symp. Conf. Rec.*, 2010, pp. 3093–3096.
- [11] T. Kato, J. Kataoka, T. Nakamori, T. Miura, H. Matsuda, K. Sato, Y. Ishikawa, K. Yamamura, N. Kawabata, H. Ikeda, G. Sato, and K. Kamada, "Development of a large-area monolithic 4×4 MPPC array for a future PET scanner employing pixelized Ce:LYSO and Pr:LuAG crystals," *Nucl. Instr. Meth.*, vol. A638, pp. 83–91, 2011.
- [12] T. Kato, J. Kataoka, T. Nakamori, T. Miura, H. Matsuda, A. Kishimoto, K. Sato, Y. Ishikawa, K. Yamamura, N. Kawabata, H. Ikeda, S. Yamamoto, and K. Kamada, "A novel gamma-ray detector with sub-millimeter resolutions using a monolithic MPPC array with pixelized Ce:LYSO and Ce:GGAG crystals," *Nucl. Instr. Meth.*, submitted for publication.
- [13] T. Nakamori, T. Kataoka, J. Kataoka, T. Miura, H. Matsuda, K. Sato, Y. Ishikawa, K. Yamamura, N. Kawabata, H. Ikeda, G. Sato, and K. Kamada, "Development of a gamma-ray imager using a large area monolithic 4×4 MPPC array for a future PET scanner," *JINST*, submitted for publication.
- [14] K. Kamada, T. Endo, and K. Tsutumi, "Composition engineering in cerium-doped $(\text{Lu, Gd})_3(\text{Ga, Al})_5\text{O}_{12}$ single-crystal scintillators," *Cryst. Growth Des.*, vol. 11, pp. 4484–4490, 2011.